

DESCRIPCIÓN	COSTO UNIDAD X DÍA	QTY MÁX	
<b>CÁMARAS</b>			
<p><b>ARRI Alexa Mini – Super 35</b></p> <ul style="list-style-type: none"> <li>- 4:3, ArriRaw &amp; Look Library</li> <li>- 5 Tarjetas Cfast 256 GB</li> <li>- 4 Baterías V-Mount</li> <li>- PL &amp; EF Mount</li> <li>- V-Mount &amp; Gold Mount</li> <li>- Tilta Cage 2</li> <li>- Shoulder Mount</li> <li>- EVF</li> <li>- Alimentación AC para cámara</li> </ul>	\$800	1	
<p><b>Blackmagic Ursa Mini 4.6K – Cinema Camera 4.6k</b></p> <ul style="list-style-type: none"> <li>- Quick Release</li> <li>- 2 Tarjetas Cfast 128 GB</li> <li>- 2 Baterías V-Mount</li> <li>- Shoulder-Mount</li> <li>- Lector de Tarjetas Cfast</li> <li>- Alimentación AC para cámara</li> </ul>	\$250	1	
<p><b>Blackmagic Pocket – Cinema Camera 6K – Super 35</b></p> <ul style="list-style-type: none"> <li>- V-Mount battery por cable AC a D-Tap</li> <li>- Tilta Cage</li> <li>- Alimentación AC para cámara</li> <li>- 2 Tarjetas Cfast 128 GB</li> <li>- V- Mount / Bateria Grip (canon 3 baterias)</li> </ul>	\$200	1	

<p><b>Sony FX3 Cinema Line Camera – Full Frame</b></p> <ul style="list-style-type: none"> <li>- Tilta Cage</li> <li>- 4 x baterías sony.</li> <li>- 2 x baterías genericas</li> <li>- 2 Tarjetas tipo A de 80GB c/u</li> <li>- 1 Tarjeta tipo A de 160Gb</li> <li>- Lector de tarjetas</li> </ul>	<p>\$180</p>	<p>1</p>	
<p><b>Canon R5 Mirrorless Digital Camera – Full Frame</b></p> <ul style="list-style-type: none"> <li>- SmallRig Cage</li> <li>- 4 x baterías.</li> <li>- 2 tarjetas de 512GB c/u</li> <li>- Lector de tarjetas</li> </ul>	<p>\$200</p>	<p>1</p>	
<p><b>Insta360 X4 360° 8K Camera</b></p> <ul style="list-style-type: none"> <li>- 8K30/5.7K60 360° Cinematic H.265 Video</li> <li>- 360° Post Reframing, Longer Runtime</li> <li>- 5.7K120 Bullet Time, 11K Time-Lapse</li> <li>- FlowState Stabilization, Horizon Lock</li> <li>- 33' Waterproof, 72MP Photos</li> <li>- App with Edit Suite and Effects</li> <li>- Invisible Selfie Stick Feature</li> </ul>	<p>\$100</p>	<p>1</p>	
<p><b>Drone – Phantom DJI 4 Pro v2</b></p> <ul style="list-style-type: none"> <li>- Con operador certificado comercial + 6 Baterías</li> <li>- 4k H264 8 Bits</li> </ul>	<p>\$350</p>	<p>1</p>	
<p><b>Drone – Mavic 3 Cine</b></p> <ul style="list-style-type: none"> <li>- Con operador certificado comercial + 5 Baterías</li> <li>- Filtros ND, Pola, NDV</li> <li>- 5.1K Prores HQ 10 bits</li> </ul>	<p>\$500</p>	<p>1</p>	

ESTABILIZADORES Y SLIDERS

**Estabilizador Ronin RS3 Pro Combo – DJI**

- DJI Roll Axis Counterweight set
- DJI LiDAR Focus System
- Raven Eye (Tracking y visualización en el app)

\$130

1

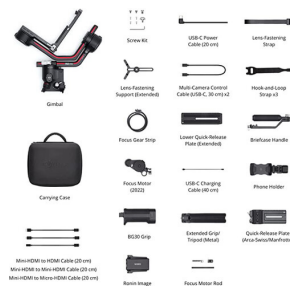

**Estabilizador Ronin RS3 Pro Combo + Tilta RING**

- DJI Roll Axis Counterweight set
- DJI LiDAR Focus System
- Raven Eye (Tracking y visualización en el app)
- V-Mount Plate
- External D-tap + Monitor mount

\$155

1



**SMALLRIG Placa base de fuente de alimentación**

- DJI RS 2 / RS 3 Pro/RS 4 Pro

\$20





1



<p><b>Slider, ASHANKS 47” – 120 cm</b></p> <ul style="list-style-type: none"> <li>- 44lb/20kg para cámara DSLR – Motor silencioso</li> </ul>	<p>\$30</p>	<p>1</p>	
<p><b>Danna Dolly PROAIM</b></p> <ul style="list-style-type: none"> <li>- Tubos de 80cm, 1,5m y 3m</li> </ul>	<p>\$100</p>	<p>1</p>	
<p><b>Flycam Flowline - (FLCM-FLN-850N) – “Easy Rig”</b></p> <ul style="list-style-type: none"> <li>- Soporta 6.6 lbs a 37.5 lbs</li> <li>- Sistema de soporte para cámara estabilizadora profesional</li> </ul>	<p>\$80</p>	<p>1</p>	
<p><b>FLYCAM Brazo de resorte de dos ejes Flowline Placid para soportes de cámara Flycam Flowline..</b></p> <ul style="list-style-type: none"> <li>- Carga útil de hasta 5kg/11lb a 20kg/44lb</li> </ul>	<p>\$20</p>	<p>1</p>	

MONITORES

<p><b>Monitor OSEE 21.5" LCM215-HDR+</b></p> <ul style="list-style-type: none"> <li>- Monitor para Cliente 10 Bits</li> <li>- Materias V-Mount</li> <li>- AC</li> <li>- Parasol</li> <li>- Montura para C Stand</li> </ul>	<p>\$135</p>	<p>1</p>	
<p><b>Monitor OSEE Megamon 15" HDR</b></p> <ul style="list-style-type: none"> <li>- Monitor para Director 10 Bits</li> <li>- Materias V-Mount</li> <li>- AC</li> <li>- Parasol</li> <li>- Montura para C Stand</li> </ul>	<p>\$100</p>	<p>1</p>	
<p><b>Monitor SmallHD ULTRA 7 Bolt 6 RX 750</b></p> <ul style="list-style-type: none"> <li>- 7" 1920 x 1080 Touchscreen Display</li> <li>- Built-In Bolt 6 Wireless Receiver</li> <li>- V-Mount Battery Plate</li> <li>- 6 GHz Wireless Transmission up to 750'</li> <li>- Bright 2300 cd/m<sup>2</sup> LCD Panel</li> <li>- 10-Bit 4:2:2 DCI-P3 Color Gamut</li> <li>- Sun Hood</li> </ul>	<p>\$140</p>	<p>1</p>	
<p><b>Monitor SmallHD ULTRA 7 Bolt 6 RX 750 + Transmisor Bolt 6 TX 750</b></p> <ul style="list-style-type: none"> <li>- 7" 1920 x 1080 Touchscreen Display</li> <li>- 6G-SDI &amp; HDMI I/O; Up to 4K Video</li> <li>- V-Mount Battery Plate</li> <li>- 6 GHz Wireless Transmission up to 750'</li> <li>- Bright 2300 cd/m<sup>2</sup> LCD Panel</li> <li>- 10-Bit 4:2:2 DCI-P3 Color Gamut</li> <li>- 3G-SDI and HDMI Input, SDI Output</li> </ul>	<p>\$185</p>	<p>1</p>	
<p><b>Monitor SmallHD ULTRA 7 Bolt 6 RX 750 + Bolt 6 TX 750</b></p> <ul style="list-style-type: none"> <li>- 7" 1920 x 1080 Touchscreen Display</li> <li>- Bolt 6 Wireless System</li> <li>- V-Mount Battery Plate</li> <li>- 6 GHz Wireless Transmission up to 750'</li> <li>- Bright 2300 cd/m<sup>2</sup> LCD Panel</li> <li>- 10-Bit 4:2:2 DCI-P3 Color Gamut</li> <li>- 3G-SDI and HDMI Input, SDI Output</li> </ul>	<p>\$200</p>	<p>1</p>	

<p><b>Monitor SmallHD 702 7"</b></p> <ul style="list-style-type: none"> <li>- Parasol</li> </ul>	<p>\$50</p>	<p>1</p>	
<p><b>Monitor Hollyland Mars M1 5"</b></p> <ul style="list-style-type: none"> <li>- Transmisor o Receptor dentro de la línea Mars Hollyland</li> <li>- Ultra-Bright</li> <li>- SDI/HDMI</li> </ul>	<p>\$55</p>	<p>1</p>	
<p><b>Monitor Hollyland Mars M1 5" + Receiver Mars 400s Pro</b></p> <ul style="list-style-type: none"> <li>- Transmisor o Receptor dentro de la línea Mars Hollyland</li> <li>- Ultra-Bright</li> <li>- Transmisor o Receptor Mars 400s Pro</li> <li>- SDI/HDMI</li> </ul>	<p>\$90</p>	<p>1</p>	
<p><b>Monitor SmallHD Action 5"</b></p> <ul style="list-style-type: none"> <li>- Pantalla Táctil</li> <li>- Ultra-Bright</li> </ul>	<p>\$40</p>	<p>1</p>	
<p><b>Monitor SmallHD Focus 5"</b></p> <ul style="list-style-type: none"> <li>- Pantalla Táctil</li> <li>- Parasol</li> <li>- Cage</li> </ul>	<p>\$35</p>	<p>1</p>	

ÓPTICAS

<p><b>ARRI Ultra Prime Set (PL Mount):</b></p> <ul style="list-style-type: none"> <li>- 16mm – T1.9</li> <li>- 24mm – T1.9</li> <li>- 32mm – T1.9</li> <li>- 50mm – T1.9</li> <li>- 85mm – T1.9</li> </ul>	<p>\$390</p>	<p>1</p>	
<p><b>Set Anamórfico BLAZAR Remus 1.5X (PL Mount)</b></p> <ul style="list-style-type: none"> <li>- 35mm T1.6</li> <li>- 45mm T2</li> <li>- 65mm T2</li> <li>- 85 mm T2.8</li> <li>- 100mm T2.8</li> <li>- 125mm T4</li> </ul>	<p>\$285</p>	<p>1</p>	
<p><b>Set Contax Zeiss Súper Speed (Cine MOD EF Mount):</b></p> <ul style="list-style-type: none"> <li>- 21mm f/2.8</li> <li>- 28 mm f/2</li> <li>- 35mm f/1.4</li> <li>- 50 mm f/1.4</li> <li>- 85mm f/1.4.</li> </ul>	<p>\$265</p>	<p>1</p>	
<p><b>Set Canon FD Vintage Lens (Cine MOD EF Mount):</b></p> <ul style="list-style-type: none"> <li>- 20mm f/2.8 SSC</li> <li>- 24mm f/2 nFD</li> <li>- 28mm f/2 SSC</li> <li>- 35mm f/2 SSC</li> <li>- 55 mm f/1.2 SSC</li> <li>- 85mm f/1.2 nFD</li> </ul>	<p>\$235</p>	<p>1</p>	
<p><b>Set Lentes Soviéticos MIR HELIOS JUPITER (Iron Glass Cine MOD) - EF mount:</b></p> <ul style="list-style-type: none"> <li>- 20mm f/3.5</li> <li>- 28mm f/3.5</li> <li>- 37mm f/2.8</li> <li>- 58mm f/2</li> <li>- 85mm f/2</li> <li>- 135mm f/2.8</li> </ul>	<p>\$200</p>	<p>1</p>	
<p><b>Set Lentes Pentax Super Takumar – Montura M42</b></p> <ul style="list-style-type: none"> <li>- 28mm f/3.5, 50mm macro f/4, 55mm f/1.8, 135mm f/2, 200mm f/4</li> <li>- Adaptador de M42 a EF</li> <li>- Adaptador de M42 a Sony E</li> </ul>	<p>\$120</p>	<p>1</p>	

<p><b>Set Lentas Rokinson EF mount:</b></p> <ul style="list-style-type: none"> <li>- 14mm –T3.5</li> <li>- 35mm – T1.5</li> <li>- 85mm – T1.5</li> </ul>	\$75	1	
<p><b>ARRI Ultra Prime 12mm - T2 (PL Mount)</b></p>	\$165	1	
<p><b>Nikor Fisheye 8mm - T2,8 (PL Mount)</b></p>	\$135	1	
<p><b>Venus Optics LAOWA Pro2be 24mm T8 2x Probe Lens</b></p> <ul style="list-style-type: none"> <li>- PL Mount</li> <li>- E Mount (Sony)</li> <li>- EF Mount (Canon)</li> </ul>	\$160	1	
<p><b>Canon RF 28-70mm f/2 L USM</b></p>	\$110	1	
<p><b>Sony FE 24-70mm f/2.8 GM II</b></p>	\$85	1	



<p>Sony FE 50mm f/1.2 GM</p>	<p>\$100</p>		
<p>Canon EF 70-200mm f/2.8L IS III USM Lens</p>	<p>\$100</p>	<p>1</p>	
<p>Canon EF 100-400mm f/4.5-5.6L IS II USM Lens</p>	<p>\$100</p>	<p>1</p>	
<p>Lente Canon EF Mount 50mm F/1.8</p>	<p>\$10</p>	<p>1</p>	
<p>Lente Canon (Tipo Pancake) 24mm F/2.8</p>	<p>\$10</p>	<p>1</p>	
<p>Lente Sigma ART (Zoom Angular – EF Mount) - 14-24 mm f/2.8</p>	<p>\$100</p>	<p>1</p>	
<p>Aivascope 1.5X (Blue Flare)</p>	<p>\$110</p>	<p>1</p>	
<p>Sigma MC-11 Adaptador (Canon EF a Sony E-Mount)</p>	<p>\$10</p>	<p>1</p>	

<p><b>Adaptador (m42 a Sony E-Mount)</b></p>	<p>\$2</p>	<p>1</p>	
<p><b>Adaptador (m42 a EF-Mount)</b></p>	<p>\$2</p>	<p>1</p>	
<p><b>FOLLOW FOCUS</b></p>			
<p><b>Follow Focus Wireless – Tilta Nucleus Nano</b></p>	<p>\$65</p>	<p>1</p>	
<p><b>Tilta Nucleus-M Follow Focus Wireless Lens Control System</b></p>	<p>\$120</p>	<p>2</p>	
<p><b>DJI Focus Pro Creator Combo</b></p>	<p>\$100</p>	<p>1</p>	
<p><b>Tilta FF-T06 Mini Follow Focus Manual</b></p>	<p>\$15</p>	<p>1</p>	
<p><b>TRANSMITION</b></p>			
<p><b>Transmisor de Video Inalámbrico Hollyland Mars 400S Pro</b></p> <ul style="list-style-type: none"> <li>- 1080p HDMI&amp;SDI 5G Wireless Video &amp; Audio Transmission 400ft 0.06s Latency</li> </ul>	<p>\$50</p>	<p>1</p>	





<p><b>DJI SDR Transmission Combo</b></p> <ul style="list-style-type: none"> <li>- Transmit up to 1080p60 Video</li> <li>- SDR Tri-Bandwidth Technology</li> <li>- DFS, 2.4 &amp; 5.8 GHz with Auto Hopping</li> </ul>	\$85	1	
<p><b>Teradek Bolt 6 LT 750 3G-SDI/HDMI Transmitter/Receiver Kit</b></p> <ul style="list-style-type: none"> <li>- ZERO Latency</li> <li>- 3G-SDI/HDMI Transmitter &amp; Receiver Set</li> <li>- Internal Antennas Transmitter &amp; Receiver</li> <li>- Supports 6 GHz Frequency Band</li> <li>- Transmits up to 750' Line of Sight</li> </ul>	\$135	1	
<p><b>Aputure Sidus One Wireless DMX Transceiver</b></p> <ul style="list-style-type: none"> <li>- Transmit or Receive Any Protocol</li> <li>- Designed for Sidus Link Pro App</li> <li>- CRMX/DMX/Sidus Bluetooth Transmitter</li> <li>- Wi-Fi sACN/Art-Net Node</li> <li>- CRMX Receiver with Wired DMX Conversion</li> <li>- Enhances and Extends Sidus Mesh Networks</li> <li>- 5.8 GHz Frequency Wi-Fi</li> </ul>	\$85	1	
<p><b>OREI Interruptor HDMI multivisor 4x1</b></p> <ul style="list-style-type: none"> <li>- Conmutador HDMI 4x1 con visor HDMI múltiple: admite 4 fuentes de entrada HDMI a un solo</li> </ul>	\$10	1	
<p><b>Mini Recorder Ultra Studio</b></p>	\$25	1	
<b>SONIDO</b>			
<p><b>Micrófono de Solapa – Sennheiser Pro EW 112P G4</b></p> <ul style="list-style-type: none"> <li>- Transmisor y Receptor</li> </ul>	\$35	1	
<p><b>DJI Mic Dual-Transmitter Compact Digital Wireless Microphone</b></p> <ul style="list-style-type: none"> <li>-</li> </ul>	\$35	2	

<p><b>Grabadora Zoom H2N</b></p>	<p>\$15</p>	<p>1</p>	
<p><b>Deity V-Mic D4 Mini Ultracompact Camera- Shotgun</b></p> <ul style="list-style-type: none"> <li>- Input Jack Allows Secondary Audio Source</li> </ul>	<p>\$15</p>	<p>1</p>	
<p>ACCESORIOS CÁMARAS</p>			
<p><b>Matte Box Tilta Mirage</b></p> <ul style="list-style-type: none"> <li>- ND variable VAXIS</li> <li>- Rota Pola VAXIS</li> <li>- Soporte para Rods 15mm</li> <li>- Clamp con Maximo de 95mm</li> <li>- Adaptable a 82mm, 77mm, 72mm y 67mm</li> </ul> <p>Soporte para Filtros 4 x 5,65"</p>	<p>\$50</p>	<p>1</p>	
<p><b>Matte box FOTGA DP500 Mark iii 4x4</b></p> <ul style="list-style-type: none"> <li>- Soporte para Rods 15mm</li> <li>- Soporte para Filtros 4x4</li> </ul>	<p>\$30</p>	<p>1</p>	
<p><b>Matte Box Tilta Mini Clamp</b></p> <ul style="list-style-type: none"> <li>- Soporte para Filtros 4 x 5,65"</li> <li>- Soporte para Rods 15mm</li> <li>- Clamp con Maximo de 82mm</li> <li>- Adaptable a 77mm, 72mm y 67mm</li> </ul>	<p>\$15</p>	<p>1</p>	
<p><b>Shoulder Mount Blackmagic</b></p>	<p>\$10</p>	<p>1</p>	



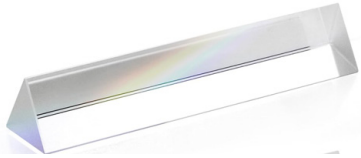

Shoulder Mount	\$5	1	
Quick Release	\$5	1	
Noga Cine Arm – Brazo para monitor	\$10	2	
Noga Cine Arm Small – Brazo para monitor	\$8	1	
Tilta Mini Articulating Arm	\$8	1	
D-Tap Splitter Male to 4 Port Female D-Tap Hub	\$2	1	

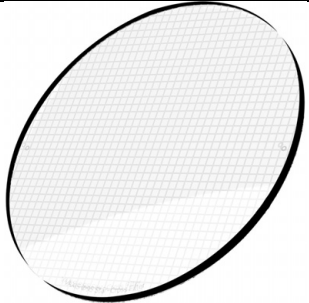
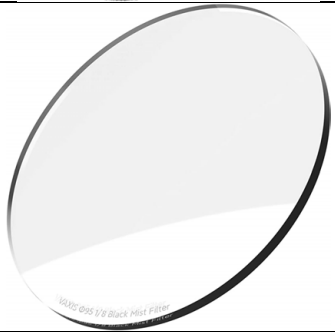
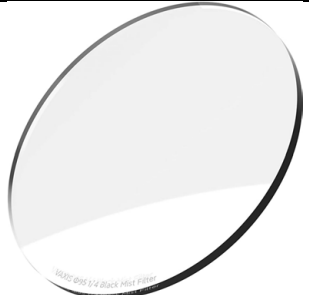
D-Tap Splitter Male to 4 Port Female D-Tap Hub	\$2	1	
D-Tap de metal con protección contra sobretensiones	\$5	1	
FILTROS			
Filtro de Densidad variable 77mm – Tiffen	\$15	1	
Filtro de Densidad variable 58mm – Tiffen	\$15	1	
Filtro Pola 77mm – Hoya	\$15	1	
Dream FX Filters 77mm – PRISM LENS FX	\$20	1	

Cinema Hard Stop VND V2 - 77mm PRISM LENS FX	\$20	1	
Nostalgia FX Filter 77MM - PRISM LENS FX	\$20	1	
Lucid Dream FX 77mm - PRISM LENS FX	\$20	1	
Chromatic Flare FX Filter 77mm - PRISM LENS FX	\$20	1	
Split Subtle Kaleidoscope FX 77mm - PRISM LENS FX	\$15	1	
Vortex Effect Filter 82mm	\$15	1	

Mountable Triangle Prism - PRISM LENS FX		1	
Filtro Black Pro-Mist 1/4 77mm	\$15	1	
Filtro Black Pro-Mist 1/8 77mm	\$15	1	
Tiffen Filtro de protección UV 77VP 77mm	\$5	4	
Vaxis 95mm Star-Cross Filter for Tilta Mirage Matte Box	\$15	1	
Vaxis 95mm Black Mist 1/8 Filter for Tilta Mirage	\$15	1	
Vaxis 95mm Black Mist 1/4 Filter for Tilta Mirage	\$15	1	

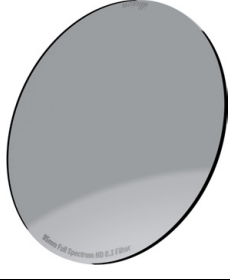
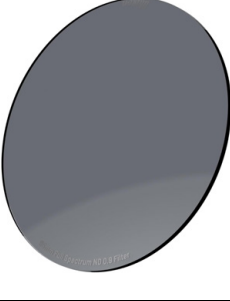







<p>Illusion 95mm Black Mist 1/2 Filter for Tilta Mirage</p>	<p>\$15</p>		
<p>Tilta 95mm Polarizer Filter for Tilta Mirage</p>	<p>\$20</p>	<p>1</p>	
<p>Tilta 95mm ND variable de 3.740 in para Tilta Mirage</p>	<p>\$20</p>	<p>2</p>	
<p>Illusion 95mm - Filtro ND 0.3 de espectro completo</p>	<p>\$15</p>	<p>1</p>	
<p>Illusion 95mm - Filtro ND 0.9 de espectro completo</p>	<p>\$15</p>	<p>1</p>	
<p>Illusion 95mm - Filtro ND 2.1 de espectro completo</p>	<p>\$15</p>	<p>1</p>	

## EQUIPO DE LUCES

<p><b>Nanlux Evoke 2400B Bi-Color LED</b></p> <ul style="list-style-type: none"> <li>- Combo Stand</li> <li>- 45° Reflector</li> <li>- Compatible con app NanLink</li> </ul>	\$180	1	
<p><b>Aputure STORM 1000c Cine Kit</b></p> <ul style="list-style-type: none"> <li>- Combo Stand</li> <li>- BLAIR LED Monolight</li> <li>- Skid Flat Support</li> <li>- CF12 15-45° Compact Bowens Fresnel</li> <li>- 8-Leaf CF12 Barndoors</li> <li>- Compatible con app Sidus Link</li> </ul>	\$165		
<p><b>Aputure STORM 1000c</b></p> <ul style="list-style-type: none"> <li>- Combo Stand</li> <li>- BLAIR LED Monolight</li> <li>- Conos (Wide, Medium, Narrow)</li> <li>- Compatible con app Sidus Link</li> </ul>	\$145		
<p><b>Aputure STORM 1200x Pro Bi-Color LED</b></p> <ul style="list-style-type: none"> <li>- Combo Stand</li> <li>- BLAIR LED</li> <li>- Conos (Wide, Medium, Narrow)</li> <li>- <b>Compatible con app Sidus Link</b></li> </ul>	\$145	1	

<p><b>Nanlux Evoke 1200 LED Light</b></p> <ul style="list-style-type: none"> <li>- Combo Stand</li> <li>- Fresnel F35</li> <li>- Compatible con app NanLink</li> </ul>	<p>\$135</p>	<p>1</p>	
<p><b>Aputure LS 1200d Pro</b></p> <ul style="list-style-type: none"> <li>- Combo Stand</li> <li>- Conos (Wide, Medium, Narrow)</li> <li>- <b>Compatible con app Sidus Link</b></li> </ul>	<p>\$125</p>	<p>1</p>	
<p><b>Aputure LS 600d Pro</b></p> <ul style="list-style-type: none"> <li>- C-Stand</li> <li>- Fresnel F10 (o modificador a escoger)</li> <li>- <b>Compatible con app Sidus Link</b></li> </ul>	<p>\$100</p>	<p>1</p>	
<p><b>Aputure LS 600c Pro RGB LED</b></p> <ul style="list-style-type: none"> <li>- C-Stand</li> <li>- Fresnel F10 (o modificador a escoger)</li> <li>- <b>Compatible con app Sidus Link</b></li> </ul>	<p>\$100</p>	<p>1</p>	
<p><b>Aputure NOVA P300c RGBWW LED Panel</b></p> <ul style="list-style-type: none"> <li>- Rolling Case Kit</li> <li>- <b>Compatible con app Sidus Link</b></li> </ul>	<p>\$90</p>	<p>1</p>	

<p><b>Aputure 300d Mark II Led</b></p> <ul style="list-style-type: none"> <li>- C-Stand</li> <li>- V Mount Battery Plate</li> <li>- <b>Compatible con app Sidus Link</b></li> </ul>	\$40	1	
<p><b>Aputure Amaran 200d LED Light</b></p> <ul style="list-style-type: none"> <li>- <b>Compatible con app Sidus Link</b></li> </ul>	\$30	1	
<p><b>Aputure STORM 80c</b></p> <ul style="list-style-type: none"> <li>- Stand</li> <li>- BLAIR LED Monolight</li> <li>- Compatible con app Sidus Link</li> <li>- Fresnel</li> </ul>	\$40	1	
<p><b>Amaran COB 60x BiColor 65W</b></p> <ul style="list-style-type: none"> <li>- <b>LED CCT</b></li> <li>- <b>Soporte para Bateria NP</b></li> <li>- <b>Compatible con app Sidus Link</b></li> </ul>	\$25	2	
<p><b>ARRI 650w Plus Fresnel</b></p> <ul style="list-style-type: none"> <li>- Tungsteno</li> <li>- Set de Screen</li> <li>- Bandoors</li> </ul>	\$30	4	

<p><b>Amaran F22c 2x2 RGB LED Flexible</b></p> <ul style="list-style-type: none"> <li>- LED RGB</li> <li>- Soporte para Bateria V Mount</li> <li>- Compatible con app Sidus Link</li> </ul>	<p>\$40</p>	<p>1</p>	
<p><b>Amaran F21c 2x1 RGB LED Flexible</b></p> <ul style="list-style-type: none"> <li>- LED RGB</li> <li>- Soporte para Bateria V Mount</li> <li>- Compatible con app Sidus Link</li> </ul>	<p>\$35</p>	<p>1</p>	
<p><b>Falcon Eyes RX-18TDX II Bi-Color Rollflex</b></p> <ul style="list-style-type: none"> <li>- Softbox con Honey Grid</li> <li>- Control a distancia</li> </ul>	<p>\$30</p>	<p>1</p>	
<p><b>Nanlite PavoTube II 30X 2-Light Kit (4')</b></p> <ul style="list-style-type: none"> <li>- Tubos RGB</li> <li>- Soporte para Bateria V Mount</li> </ul>	<p>\$65</p>	<p>2</p>	
<p><b>Nanlite PavoTube II 15X 2-Light Kit (2')</b></p> <ul style="list-style-type: none"> <li>- Tubos RGB</li> <li>- Soporte para Bateria V Mount</li> </ul>	<p>\$50</p>	<p>1</p>	
<p><b>Nanlite PavoTube II 6C de 10"</b></p> <ul style="list-style-type: none"> <li>- Tubos RGB</li> </ul>	<p>\$15</p>	<p>1</p>	

<p><b>Luz Quassar Science Q-Lion Maleta</b></p> <ul style="list-style-type: none"> <li>- 3 tubos Led (24" – 12" – 7")</li> <li>- 3 temperaturas (5600 – 4000 – 3200)</li> </ul>	<p>\$30</p>	<p>1</p>	
<p><b>Aputure MC Pro RGBWW LED</b> Compatible con app Sidus Link</p>	<p>\$10</p>	<p>1</p>	
<p><b>Aputure MC RGBWW LED</b></p> <ul style="list-style-type: none"> <li>- Compatible con app Sidus Link</li> </ul>	<p>\$10</p>	<p>1</p>	
<p><b>Aputure B7c RGBWW LED</b></p> <ul style="list-style-type: none"> <li>- Compatible con app Sidus Link</li> </ul>	<p>\$10</p>	<p>2</p>	
<p>ACCESORIOS LUCES</p>			
<p><b>Aputure Light Dome 150</b></p> <ul style="list-style-type: none"> <li>- Series Bowens</li> <li>- 2 Densidades de Filtro</li> <li>- Honey Grid</li> </ul>	<p>\$20</p>	<p>1</p>	







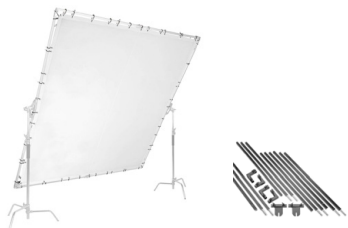

<p><b>Aputure Light Dome III (35,1")</b></p> <ul style="list-style-type: none"> <li>- Series Bowens</li> <li>- 2 Densidades de Filtro</li> <li>- Honey Grid</li> </ul>	<p>\$15</p>	<p>1</p>	
<p><b>Aputure Light Dome II (34.8")</b></p> <ul style="list-style-type: none"> <li>- Series Bowens</li> <li>- Con porta Filtro</li> <li>- 2 Densidades de Filtro</li> </ul> <p>Honey Grid</p>	<p>\$12</p>	<p>1</p>	
<p><b>Aputure Light Dome SE Softbox 33.5 pulgadas</b></p> <ul style="list-style-type: none"> <li>- Series Bowens</li> <li>- 2 Densidades de Filtro</li> <li>- Honey Grid</li> </ul>	<p>\$10</p>	<p>1</p>	
<p><b>Aputure Light Dome Mini II</b></p> <ul style="list-style-type: none"> <li>- Series Bowens</li> </ul>	<p>\$12</p>	<p>2</p>	
<p><b>Light Dome 40</b></p> <ul style="list-style-type: none"> <li>- Compact softbox designed for the STORM 80c</li> </ul>	<p>\$10</p>	<p>1</p>	
<p><b>Aputure Softbox for P300c LED Panel</b></p>	<p>\$10</p>	<p>1</p>	
<p><b>Impact Fabric Grid for Large Octagonal Luxbanx (84")</b></p>	<p>\$20</p>	<p>1</p>	
<p><b>Godox Softbox Grid (19,7 x 51,2")</b></p>	<p>\$10</p>	<p>1</p>	

<p>Aputure Lantern 90 (3')</p>	<p>\$15</p>	<p>1</p>	
<p>Aputure Lantern Softbox (2.2')</p>	<p>\$10</p>	<p>1</p>	
<p>Nanlite Fabric Barndoors/Grid - PavoTube II 30X</p>	<p>\$8</p>	<p>4</p>	
<p>Nanlite Fabric Barndoors/Grid - PavoTube II 15X</p>	<p>\$5</p>	<p>2</p>	
<p>Snapgrid 40 - Aputure Nova P300C</p>	<p>\$5</p>	<p>1</p>	
<p>TRP SNAPGRID for 4 x 4' Frame (40°)</p>	<p>\$15</p>	<p>1</p>	



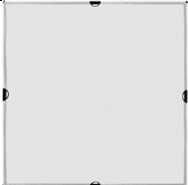

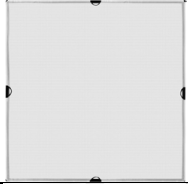

<p><b>TRP SNAPGRID for 6 x 6' Frame (50°)</b></p>	<p>\$20</p>	<p>1</p>	
<p><b>Aputure Barndoors for Nova P300c</b></p>	<p>\$5</p>	<p>1</p>	
<p><b>Aputure Barndoors</b>  - Para Aputure 120D Mark 2, Aputure 120D, Aputure 300D con soporte Bowens</p>	<p>\$5</p>	<p>1</p>	
<p><b>Aputure F10 Barndoors</b> for LS 600d Fresnel Attachment</p>	<p>\$12</p>	<p>1</p>	
<p><b>Nanlux F-35 10° Fresnel Attachment for Evoke 1200</b></p>	<p>\$50</p>	<p>1</p>	
<p><b>Nanlux 26° 45° 60° Reflector Kit for Evoke 1200</b></p>	<p>\$30</p>	<p>1</p>	 <p style="text-align: center;"> <span>RF-NLM-26</span>      <span>RF-NLM-45</span>      <span>RF-NLM-60</span> </p>





<p><b>Aputure F10 Fresnel Attachment</b> for LS 600d LED Light</p>	<p>\$25</p>	<p>2</p>	
<p><b>Aputure Fresnel 2X Attachment</b> for LS 300d LED Light</p>	<p>\$15</p>	<p>1</p>	
<p><b>Snoot monture Bowens</b></p>	<p>\$3</p>	<p>1</p>	
<p><b>Aputure Spotlight MAX</b></p> <ul style="list-style-type: none"> <li>- Optimizado para 600d, 600c, 1000c, 1200d y 1200x</li> <li>- 36° Lens</li> <li>- 13 Gobos</li> <li>- Iris</li> </ul>	<p>\$70</p>		
<p><b>Aputure Spotlight</b></p> <ul style="list-style-type: none"> <li>- Compatible con 60x, 200d, 300d, 600d (con perdida).</li> <li>- 26° o 19° Lens</li> <li>- 13 Gobos</li> <li>- Iris</li> </ul>	<p>\$35</p>	<p>1</p>	
<p><b>Matthews Butterfly/Overhead Light Duty Frame - 12x12'</b></p> <ul style="list-style-type: none"> <li>- 12x12' - White Artificial Silk</li> <li>- 12x12' - White China Silk</li> <li>- 12x12' - Solid Black</li> <li>- 12x12' - Checkerboard Silver/Gold</li> <li>- 12x12' - Ultrabounce (Black/White)</li> </ul>	<p>\$100</p>	<p>1</p>	

<p><b>Avenger H1200M 12 x 12' Modular Overhead Frame</b></p> <ul style="list-style-type: none"> <li>- 12x12' - White Artificial Silk</li> <li>- 12x12' - White China Silk</li> <li>- 12x12' - Solid Black</li> <li>- 12x12' - Checkerboard Silver/Gold</li> <li>- 12x12' - Ultrabounce (Black/White)</li> </ul>	\$100	1	
<p><b>Avenger H1200M 8x8' Modular Overhead Frame</b></p> <ul style="list-style-type: none"> <li>- 8x8' - White Artificial Silk</li> <li>- 8x8' - White China Silk</li> <li>- 8x8' - Solid Black</li> </ul>	\$65	1	
<p><b>Matthews Butterfly/Overhead Light Duty Frame - 6x6'</b></p> <ul style="list-style-type: none"> <li>- 6x6' - White Artificial Silk</li> <li>- 6x6' - UltraBounce</li> <li>- 6x6' - Solid Black</li> <li>- 6x6' - Checkerboard Silver/Gold</li> </ul>	\$45	1	
<p><b>Marco Difusor ¼ Westcott Scrim Jim 4x4'</b></p>	\$25	1	
<p><b>Marco Difusor ½ Westcott Scrim Jim 4x4'</b></p>	\$25	1	
<p><b>Marco Difusor Full Westcott Scrim Jim 4x4'</b></p>	\$25	1	
<p><b>Marco Difusor 216 4x4</b></p>	\$25	2	
<p><b>Marco Difusor 250 4x4</b></p>	\$25	2	
<p><b>Marco Difusor OPAL 4x4</b></p>	\$25	2	







## GRIPERÍA

Scissor Clamp – Avenger C1000 Drop-Ceiling	\$2	6	
Impact Super Clamp with Ratchet Handle	\$2	4	
Stand Boom STUDIO	\$20	1	
Matthews Matthellini Clamp 3” End Jaw	\$4	1	
Matthews Matthellini Clamp 3” Center Jaw	\$4	3	
Matthews Matthellini Clamp 6” End Jaw	\$4	4	
Kupo Matthellini Clamp 9” End Jaw	\$4	2	
C-Clamp Heavy-Duty	\$2	1	
Matthews C - Clamp with 2- 5/8" Baby Pins - 6"	\$4	2	

<p><b>Matthews Gaffer Grip with 5/8" Pins</b></p>	<p>\$4</p>	<p>4</p>	
<p><b>Impact Plate Clamp Duckbill</b></p>	<p>\$4</p>	<p>1</p>	
<p><b>Impact Pivot Arm 20" Locking Lever</b></p>	<p>\$5</p>	<p>1</p>	
<p><b>Matthews Century C-Stand with Turtle Base and Grip Arm Kit (10.5')</b></p>	<p>\$20</p>	<p>9</p>	
<p><b>Matthews Century C-Stand with Sliding Leg and Grip Arm Kit (10.5')</b></p>	<p>\$20</p>	<p>1</p>	

<p><b>Matthews Century Baby C-Stand with Sliding Leg and Grip Arm Kit (5.25' o 1.6 metros)</b></p>	<p>\$20</p>	<p>3</p>	
<p><b>Matthews Hollywood Head, Arm – 40”</b></p>	<p>\$5</p>	<p>1</p>	
<p><b>Kupo Master High Cine Stand 3 Riser</b></p>	<p>\$25</p>	<p>5</p>	
<p><b>Kupo Master Cine Stand 2 Riser (10.6')</b></p>	<p>\$20</p>	<p>2</p>	
<p><b>Kupo Master Combo Alu Senior Stand 2 Riser (10.3')</b></p>	<p>\$20</p>	<p>1</p>	

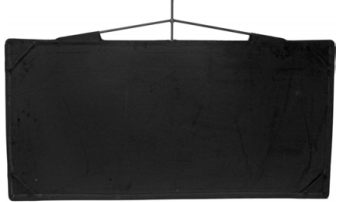
<p><b>Kupo Low Mighty Stand (6.7')</b></p>	<p>\$20</p>	<p>1</p>	
<p><b>Matthews Mini Slider Stand (38")</b></p>	<p>\$15</p>	<p>2</p>	
<p><b>Avenger D650 Junior Boom Arm</b></p>	<p>\$20</p>	<p>1</p>	
<p><b>Kupo 4-1/2" Grip Head With 1-1/8" Stud and Receiver</b></p>	<p>\$15</p>	<p>6</p>	
<p><b>Avenger F100 Junior Offset Arm (Chrome-Plated)</b></p>	<p>\$5</p>	<p>2</p>	
<p><b>Impact Telescopic Collapsible Reflector Holder</b></p>	<p>\$5</p>	<p>1</p>	



<p><b>Kupo Baby Kit Stand with Square Legs (9.5')</b></p>	<p>\$10</p>	<p>3</p>	
<p><b>Kupo Kupole (39.4", Black Powder Coated)</b></p>	<p>\$5</p>	<p>1</p>	
<p><b>Matthews Black Flag (18 x 24")</b></p>	<p>\$5</p>	<p>1</p>	
<p><b>Matthews Black Flag (24 x 36")</b></p>	<p>\$5</p>	<p>2</p>	
<p><b>Matthews 24x48" Mini Meat Axe Flag</b></p>	<p>\$7</p>	<p>1</p>	
<p><b>Floppy Cutter - 48x48" - Top Hinge (Opens to 48x90")</b></p>	<p>\$10</p>	<p>2</p>	



Impact PortaFrame Scrim Flag Kit (24 x 36")	\$15	1	
Pony Clamp 2" (Metalico)	\$1	20	
Pony Clamp 1" (Metalico)	\$1	2	
Pony Clamp 2" (Plástico)	\$1	4	
Pony Clamp Pequeño (Plástico)	\$1	4	
Sandbag de 30 Libras	\$2	12	
Sandbag de 15 Libras	\$1	12	

Extensión TCJ de 15mts – 20 Amp	\$4	2	
Extensión TCJ de 15mts – 15 Amp	\$2	4	
Extensión TCJ de 10mts – 15 Amp	\$2	4	
<b>BATERÍAS Y TARJITAS</b>			
Batería Canon LP	\$5	6	
Batería Powerextra NP-F970 (Grande) – Compatible con Sony y Monitor	\$6	4	
Batería NP Standard – Para Monitor	\$5	10	
Batería para Sony ( Alpha 7siii, Riv, 7iii,)	\$5	4	
Batería de montaje en V de 220 Wh, 15000 mAh	\$30 c/u	3	







<p>SmallRig VB155 Mini V-Mount Battery (155Wh)</p>	<p>\$25</p>	<p>1</p>	
<p>Batería V-Mount IndiPRO 98Wh</p>	<p>\$20 c/u</p>	<p>4</p>	
<p>FXLION Nano ONE V-Mount Mini</p>	<p>\$15</p>	<p>1</p>	
<p>Batería V-Mount SWIT PB-M98S 98W – con D-Tap y salida USB</p>	<p>\$20 c/u</p>	<p>2</p>	
<p>Baterías V-Mount IndiPRO 95Wh</p>	<p>\$20 c/u</p>	<p>2</p>	
<p>Cargador Doble Baterías V-Mount</p>	<p>\$10</p>	<p>2</p>	

Tarjeta de 32GB Compact Flash	\$5	2	
Tarjeta de 64GB Compact Flash	\$8	2	
Tarjeta Cfast 128 GB	\$15	2	
Tarjeta Cfast 128 GB	\$20	5	
Tarjeta SD Extreme Pro 64gb	\$5	5	
	\$5	6	
Lector de Tarjetas Cfast	\$5	1	
Batería para Drone Phantom 4 Pro	\$20	7	
Baterías NP-F550 Dummy a D-Tap	\$5	3	
Baterías LP (Canon) Dummy a D-Tap	\$5	1	

OTROS ACCESORIOS

<p><b>Claqueta de acrílico</b></p>	<p>\$5</p>	<p>1</p>	
<p><b>Máquina de Humo Hurricane Haze 4D – 1200w</b></p> <ul style="list-style-type: none"> <li>- Water-Based Hazer</li> <li>- High-Output Haze: 4300 ft<sup>3</sup>/minute</li> <li>- Low-Noise Fan</li> <li>- 2 x DMX Channels</li> </ul>	<p>\$45</p>	<p>1</p>	
<p><b>Máquina de Humo Hurricane Haze 1DX – 300w</b></p> <ul style="list-style-type: none"> <li>- Water-Based Haze Machine</li> <li>- Outputs 800 ft<sup>3</sup>/min</li> <li>- Heat-Up Time: 2 Minutes</li> <li>- Tank Capacity: 0.4 gal / 1.5L</li> </ul>	<p>\$25</p>	<p>1</p>	
<p><b>Tripode Sirui BCT-3203 Carbon Fiber BCH-30 Head</b></p> <ul style="list-style-type: none"> <li>- 100mm Bowl</li> <li>- Tensiones en Tilt y Pan</li> <li>- Cabeza Fluida</li> <li>- Soporta 39.5 lb</li> </ul>	<p>\$50</p>	<p>1</p>	
<p><b>Tripode para Video Sachtler Ace M System Black Edition</b></p> <ul style="list-style-type: none"> <li>- 75mm Bowl</li> <li>- Tensiones de 0 a 3 en Tilt y Pan</li> <li>- Cabeza Fluida</li> </ul>	<p>\$35</p>	<p>1</p>	

<p><b>Proaim Heavy-Duty Cinema Hi-Hat</b></p> <ul style="list-style-type: none"> <li>- 100mm Bowl</li> <li>- 75mm Bowl Adapter</li> </ul>	\$15	1	
<p><b>2-Axis 360° Spinning Camera Rig</b></p>	\$100	1	
<p><b>Manfrotto 502AH Pro Video Head with Flat Base</b></p>	\$12	1	
<p><b>Joby GorillaPod SLR Zoom Trípode flexible</b></p>	\$5	1	
<p><b>Shoulder Pad for support camera</b></p>	\$5	1	
<p><b>Lightweight Gimbal Support Vest</b></p>	\$15	1	

Nanlite PavoTube Double Bank T12 LED	\$4	1	
BMPCC 4K y 6k AC a D TAP para Baterías V Mount	\$5	1	
Nanlite D-Tap to 5.5mm Male DC Barrel Power Cable	\$3	2	
BMPCC 4K y 6k AC a Baterías NP	\$5	1	
Placa de batería V-Lock con Doble Abrazadera - Soporte para Rods 15mm	\$10	1	
Placa de batería V-Lock	\$5	2	
Placa para cinturón de batería V-Lock	\$4	1	
Avenger E250 Long Double 5/8" Baby Pin	\$1	2	
Double-Ended Spigot with 1/4" and 3/8"	\$1	4	
Double Ended Spigot with 5/8" Stud and 1/4"	\$1	2	

<p><b>Plate with 5/8"</b></p>	\$2	1	
<p><b>Aputure Spotlight 10-Piece Gobo Kit</b></p>	\$2	10	
<p><b>GoPro Hero 5</b></p> <ul style="list-style-type: none"> <li>- Cargador</li> <li>- 3 Baterías</li> </ul>	\$50	1	
<p><b>Generador Predator Inverter 3500</b></p>	\$100	1	
<p><b>EF ECOFLOW Estación de energía portátil RIVER 2 Max</b></p> <ul style="list-style-type: none"> <li>- 512 wh/1 hora</li> </ul>	\$40		
<p><b>Hollyland Solidcom C1 Pro Sistema de auriculares de intercomunicación inalámbrico</b></p> <ul style="list-style-type: none"> <li>- 6 Unidades</li> </ul>	\$60	6	
<p><b>Motorola Talkabout t200</b></p>	\$15	2	
<p><b>Rosco Filtros de Corrección Kit (12 x 12")</b></p> <ul style="list-style-type: none"> <li>- CTO (full - 1/2 - 1/4)</li> <li>- CTB (full - 1/2 - 1/4)</li> <li>- Minusgreen (full - 1/2 - 1/4)</li> <li>- Plusgreen (full - 1/2 - 1/4)</li> </ul>	\$5	1	
<p><b>Rosco Filtros de Color Kit (12 x 12")</b></p> <ul style="list-style-type: none"> <li>- Blue, Green, Pink, Straw, Amber, Purpule, Rose</li> </ul>	\$5	1	



## **Terminos y condiciones**

### **RECOLECCIÓN DEL EQUIPO:**

- La recolección del equipo se debe de coordinar con al menos un día de anticipación.
- Se podrá recoger el equipo el día hábil antes de la fecha de alquiler, a partir de las 3pm.
- La devolución del equipo debe efectuarse a mas tardar el día hábil posterior al último día de alquiler, antes de las 12 medio día.
- En caso de que el cliente no retire el equipo en la fecha indicada se cancelará la orden y el adelanto no se devolverá.
- Si el equipo no se devuelve en esos plazos, CitricBox Films deberá proceder a facturar los días adicionales, con un recargo del 30% de la tarifa como multa, por no haber efectuado la reserva correspondiente.
- En caso de requerir un horario especial de retiro o de devolución, favor informarlo a la productora.

### **RESPONSABILIDAD:**

- El cliente declara y acepta que revisó el equipo antes de recibirlo y que funciona perfectamente. En caso de no ser así debe reportarlo al representante de CitricBox Films, antes de retirarlo y que se anote en el documento de salida proporcionado por la productora.
- La Productora no se hará responsable por uso indebido del equipo, ya sea por desconocimiento de uso por parte del cliente o por fallos ocasionados por el mal uso del mismo.
- El uso no correcto del equipo no será razón para reclamos, reembolsos o reemplazos.
- El cliente se hará responsable por cualquier daño, robo, hurto o siniestro que sufra el equipo consignado en esta lista mientras está en su posesión. Esta responsabilidad incluye, pero no se limita a la reparación o reemplazo total del equipo que haya sido objeto de cualquier incidente, o el pago del costo de unidad nueva o su modelo actual según el precio de mercado en Costa Rica, o el costo del producto en el extranjero incluyendo los costos de envío, importación, impuestos y desalmacenaje en territorio costarricense.
- Si el equipo es devuelto con daños "leves" como raspones o señas de un uso descuidado, pero con un buen funcionamiento del mismo se cobrará una multa referente a dichos daños que varían dependiendo del equipo y su costo. \*CitricBox Films se reserva el derecho a no aceptar equipos usados como reposición por un equipo dañado o perdido.

### **CONDICIONES DE PAGO:**

El pago se realizará 50% por adelantado antes, o al retirar el equipo, y 50% al hacer la devolución del mismo en perfecto estado. Esta estructura de pago puede variar por medio de visto bueno por parte de la productora.

### **REALIZAR LOS PAGOS A:**

BAC Credomatic (dólares)  
CITRICBOX FILMS S.R.L  
Cuenta: 947121547  
IBAN: CR85010200009471215471  
Ced: 3-102809715

\*Para cualquier consulta no dude en comunicarse con nosotros al 8846-2504 / 8703-7889 al correo [sofia@citricbox.com](mailto:sofia@citricbox.com) o [vernny@citricbox.com](mailto:vernny@citricbox.com)

